

BACK VIEW

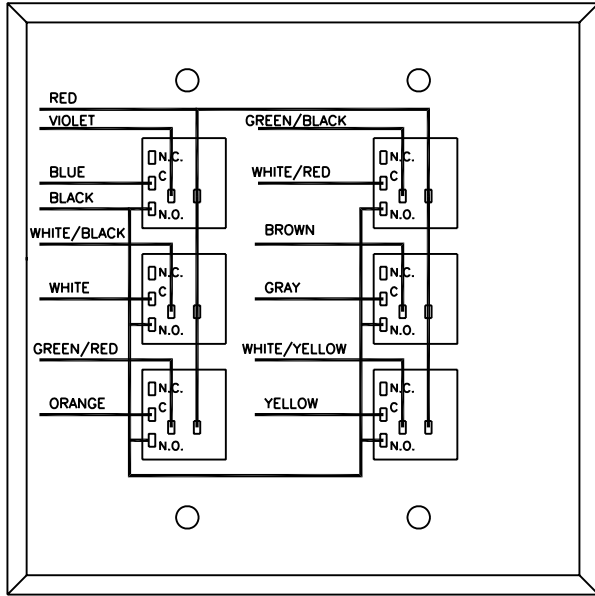

FRONT VIEW

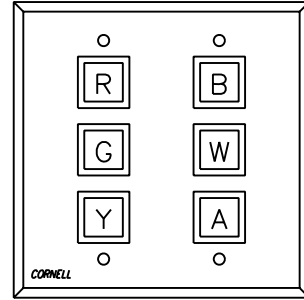

CORNELL Communications, Inc.
 sales@cornell.com 414-351-4660
 Web: www.cornell.com 414-351-4657(fax)

DATE: SEPTEMBER 25, 2006
 TITLE: S-236MS WIRING

SYSTEM: 2000 CLINIC STATUS
 DRAWING # 90066-06

BACK VIEW

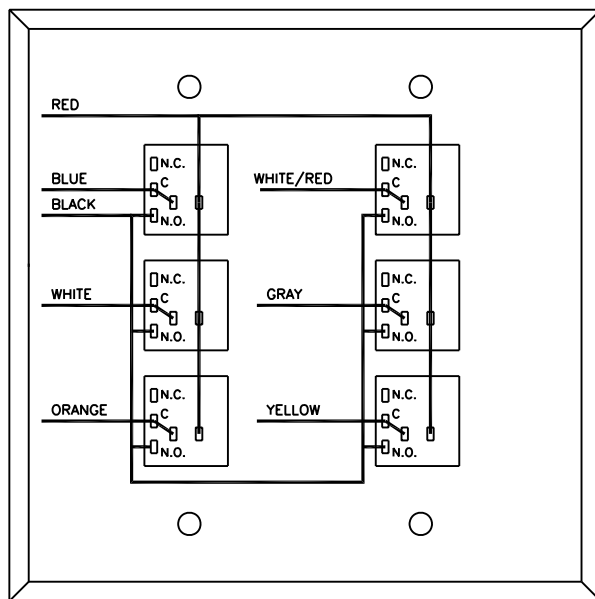

FRONT VIEW

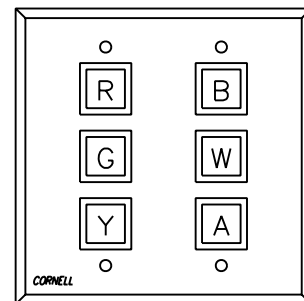

CORNELL Communications, Inc.
 sales@cornell.com 414-351-4660
 Web: www.cornell.com 414-351-4657(fax)

DATE: SEPTEMBER 25, 2006
 TITLE: S-236AS WIRING

SYSTEM: 2000 CLINIC STATUS
 DRAWING # 90067-06